

STEEL DOORS



www.unitech-ikk.com
www.sfsp-ikk.com
www.ikkgroup.com



UNITECH
For Building and Construction Materials

STEEL DOORS



FEROX Steel Doors

Index

About UNITECH	4
Steel Doors	19
Security / Detention Doors	24
Entry Gates	28
Technical Specifications & Hardware	30
Standard Hardware Options	35
Standard Materials and Finishes	38
Contact Information	40



**ABOUT
UNITECH**

Unitech Introduction

Unitech is a Saudi based Multinational Company providing building and construction solutions that is empowering the region's construction industry for the past 40+ years. We have been successfully providing solutions through mastering our main business activities: Design, Manufacture and Trade.



Design:

Provide Design & Engineering Solution to the construction sector, complying with international & local standards.



Manufacture:

Operating with Global Standards, we are widely recognized for our advanced light steel solutions and Hot-Dip Galvanization Facility.



Trade:

We are one of the region's largest Importer/Exporter of Building & Construction Materials.

Unitech is an **ISO QMS 9001:2015** certified company and is a member of the US Green Building Council. Our experienced teams and operations are present across the Middle-East North Africa regions (MENA) and Pakistan, giving us an extensive regional network that benefits our clients and partners. We are also present in Europe via our design and engineering office in Stuttgart.

For more information, please visit: www.unitech-ikk.com

Mission & Vision

Mission

UNITECH is committed to transforming the construction and building sector by equipping engineers with advanced solutions and expert support at every project stage. As a leading industry provider, we empower our team to deliver exceptional service that consistently exceeds expectations. By fostering a cohesive and forward-focused culture, we attract and retain top talent, driving our mission forward. Our innovative, customer-centric products set new industry benchmarks and pave the way for future progress.

Vision

To be the Customer's First Choice...

Our Strategy

Unitech's strategy continues to focus on accelerating its business throughout the region, to service the construction sector via superior products & solutions, backed up by a group of highly experienced people in the field. Unitech also aims to enhance its geographical presence in its areas of interest and where opportunities exist.

We combine a deep understanding of building and construction materials markets with a successful history of upgrading our products and developing our processes.

We have the qualified employees, the know-how and the products to service major construction projects, medium sized to mega projects taking in care our positive contribution to our societies.

We thrive towards excellence by acknowledging:



Customer Satisfaction



Partner and Supplier Relations



Employee Retention



Positive Influence on Society and Environment

Our Employees

We are a company that prides itself on its 'family' culture and we seek out high-caliber people. We are a company that has, at its core, a team philosophy that is clearly apparent each and every day - there is a real sense of being there for one another.

We believe in nurturing the skills of our team members and providing growing levels of responsibility. Our people bring unique skills, energy, expertise, experience and perspectives to our workforce.

Unitech's family of employees consists of experienced, well-motivated and dedicated team of engineers, technicians, sales executives and management staff. This team is committed to serve our customers, with the best solutions available in the market.

Our Journey

40+ Years of Excellence

Since 1979, having been set to become an independent company under the framework developed by Sheikh Isam Kabbani, Unitech started its journey of success with confidence and enthusiasm, hard work and care to detail and a commitment to become the best within its industry.

Its dedicated people could only imagine what the future could bring to this newly established entity. Unitech's journey of success has been marked with outstanding achievements and superior accomplishments. Year by year, Unitech has been acknowledged as the "First Choice for Building & Construction Material" by major construction consultants in the region, governmental authorities, well-known contracting and project development corporations.

We have obtained invaluable knowledge about the construction industry in general, providing specialized solutions to construction projects throughout MENA region. From a couple of outlets in Saudi Arabia, Unitech today is present all over the Kingdom and in several countries throughout the region providing its products and solution to various locations worldwide.



Est. 1979

THE BEGINNING

Unitech was established in the Western Region of KSA as a Sales Company selling basic construction material.

During the same year, another branch was established in the heart of the kingdoms capital, Riyadh.



1980 to 1989

AGE OF GREAT RISK

Unitech Dammam was open for business in the oil-rich eastern coast of Saudi Arabia.

Within these 10 years the idea of in-house manufacturing facility was born and Specialized Factory for Steel Products (SFSP) was established in Riyadh.



1990 to 1999

AGE OF GROWTH

Branches of Unitech were established in Makkah, Madina, Khamis Mushayt and Jubail.

The need to increase its range of products and the necessity to have production lines for mass production lead to the decision to move the SFSP Factory from Riyadh to Jeddah.

Pioneering Construction Since 1979

We are constantly evolving in order to become more flexible in our operations, more sustainable in our societies, and more innovative in conducting our business.

By delivering superior products tailored to the specific construction needs, ambitious solutions, and an outstanding customer service, we serve today's needs through developing tomorrow's markets.

Helping construction projects experience success is what fueled its days. Unitech is keen to continue offering superior products, a wide spectrum of solutions, governed by our top-notch management style.

Such aspirations require trust in our responsibilities. Our Responsibilities for the future and with this in mind we continue to target excellence with committed efforts.



2000 to 2015

AGE OF CONSTRUCTION BOOM

Qassim, Hofuf and Yanbu Branches were inaugurated in KSA and branches outside KSA were established in UAE, Egypt, Lebanon, Oman, Jordan and Germany in order to facilitate the construction boom in the Middle East.

During this period SFSP state of the art facilities were launched in DIC UAE and Unitech thrived, marking some of the best years in business.



2016 to 2019

AGE OF GREAT CHANGE

This period, marked the age of great change in order to align with the economic shift in the GCC and the world in general.

Company wide right sizing initiatives were taken especially in KSA to align with the kingdom's ambitious vision 2030 and during this period the upgraded SFSP state of the art facilities were launched in JIC 3 KSA.



2020 & Beyond

NEW FRONTIER

This period marks the expansion of Unitech into the South and Central Asian territories. We aim to cater these markets and play an active role in these countries development.

During 2020, Unitech Pakistan was officially inaugurated and marked the entrance of Unitech into Asian Market.

Our Manufacturing Arm

SFSP

SFSP is a leading manufacturer and fabricator of light steel construction products in the region, servicing the construction sector through its state of the art facilities which are spread all over the MENA region. Products of SFSP are manufactured from quality raw material according to the relevant international standards to meet all kinds of construction projects requirements, such as MEP, façade, blockwork & waste management systems.

Commitment to Quality

Our commitment to quality is clearly revealed in the way we do our business; our processes, our close interaction with our clients as well as the strict product inspection procedures. To achieve this, we have implemented quality systems & processes that are continually being improved to satisfy our customer's needs.

Product Development

Product development process is substantial to the success of our business. We leverage all resources to provide up-to-date reliable products, environmentally friendly, durable to withstand the toughest weather conditions. Our engineers are constantly testing the products, seeking to present a combination of performance and quality across all our product ranges.

For more information, please visit:
www.sfsp-ikk.com

Value Chain

Our value chain starts up with the quality of the raw materials and ends up in client satisfaction. Our business practices backed up by all technologically essential business elements are supported by an efficient logistics, warehousing and delivery system that maintains a valuable supply chain for products.

The value chain is integrated in our business module, giving us strength and preserving our good reputation gained through the past 4 decades.

Engineering Specialty

Our products development engineers integrate their vast knowledge to provide the perfect solution to projects within the required specifications and time-frame.

The products development department maintains highly skilled calibers with a dedication towards efficient and reliable solutions even in the most complicated cases where delicacy and skillful approaches are indispensable.

Design and Product Safety

Our design and engineering office in Stuttgart ensures our products comply with relevant European and international standards of fabrication, taking into attention the safety factors which govern the public safety of projects.

Sustainability and Responsibility

We are constantly working hard to reduce our environmental footprints while maintaining the high quality and safety standards. We have set our targets to become three times more efficient in the next 10 years. Our responsibility towards our stakeholders is valued through our positive contributions towards our colleagues, our business partners and our communities as well.

Our Design Office



UNITECH DEUTSCHLAND is a "Design & Engineering" Office. Unitech Germany support Unitech & SFSP operations through well-informed cadre of engineers. They help our customers from conception to the completion by delivering design, engineering and project management services.

Thanks to our multidisciplinary team in Unitech Germany and their expertise, we assist you in your ambition to develop your innovation, your engineering and your organization. Our goal is to serve our clients through these elements:

- Excellent in engineering ideas and solutions
- High quality in performance
- Firmness on meeting deadlines

SFSP Certifications

ISO 9001 : 2015
(Quality Management Systems)

Certificate SA09/2115

The management system of

Specialized Factory for Steel Products Co. Ltd. (SFSP)
Jeddah-Jazan Road, Industrial City No. 3, P.O. Box 50533, Jeddah, 21533, Saudi Arabia

has been assessed and certified as meeting the requirements of



ISO 9001:2015

For the following activities

Manufacture and Sales of Steel Fabricated Products such as Cladding Fixation, Gypsum Board Accessories, Plastering Accessories, Galvanized and Aluminium Cable Trays and Ladders, Block Ladder, Pipe Hanger and Clamps, Channels and Garbage and Linen Chutes and Hot Dip Galvanization

This certificate is valid from 20 December 2018 until 20 December 2021 and remains valid subject to satisfactory surveillance audits. Recertification audit due a minimum of 60 days before the expiration date. Issue 4. Certified since 20 December 2009

Authorised by

SGS United Kingdom Ltd
Rosemore Business Park, Ellesmere Port, Cheshire, CH65 3EN, UK
t+44 (0)151 350-6666 f+44 (0)151 350-6600 www.sgs.com

HC SGS 9001 2015 0818
Page 1 of 1

14001 : 2015
(Environmental Management System)

Certificate SA18/2591

The management system of

Specialized Factory for Steel Products Co. Ltd. (SFSP)
Jeddah-Jazan Road, Industrial City No. 3, P.O. Box 50533, Jeddah, 21533, Saudi Arabia

has been assessed and certified as meeting the requirements of



ISO 14001:2015

For the following activities

Manufacture and Sales of Steel Fabricated Products such as Cladding Fixation, Gypsum Board Accessories, Plastering Accessories, Galvanized and Aluminium Cable Trays and Ladders, Block Ladder, Pipe Hanger and Clamps, Channels and Garbage and Linen Chutes and Hot Dip Galvanization

This certificate is valid from 4 October 2018 until 4 October 2021 and remains valid subject to satisfactory surveillance audits. Recertification audit due a minimum of 60 days before the expiration date. Issue 1. Certified since 4 October 2018

Authorised by

SGS United Kingdom Ltd
Rosemore Business Park, Ellesmere Port, Cheshire, CH65 3EN, UK
t+44 (0)151 350-6666 f+44 (0)151 350-6600 www.sgs.com

HC SGS 14001 2015 0818
Page 1 of 1

ISO 45001 : 2018
(Occupational Health & Safety)

Certificate SA19/10111

The management system of

Specialized Factory for Steel Products Co. Ltd.(SFSP)
Jeddah-Jazan Road, Industrial City No. 3, P.O. Box 50533, Jeddah, 21533, Saudi Arabia

has been assessed and certified as meeting the requirements of



ISO 45001:2018

For the following activities

Manufacture and Sales of Steel Fabricated Products such as Cladding Fixation, Gypsum Board Accessories, Plastering Accessories, Galvanized and Aluminium Cable Trays and Ladders, Block Ladder, Pipe Hanger and Clamps, Channels and Garbage and Linen Chutes and Hot Dip Galvanization

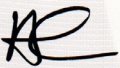

This certificate is valid from 19 February 2019 until 19 February 2022 and remains valid subject to satisfactory surveillance audits. Recertification audit due a minimum of 60 days before the expiration date. Issue 1. Certified since 19 February 2019.

Authorised by

SGS United Kingdom Ltd
Rosemore Business Park, Ellesmere Port, Cheshire, CH65 3EN, UK
t+44 (0)151 350-6666 f+44 (0)151 350-6600 www.sgs.com

HC SGS 45001 2018 0318
Page 1 of 1

This document is issued by the Company subject to its General Conditions of Certification Services accessible at www.sgs.com/terms_and_conditions.htm. Attention is drawn to the limitation of liability, indemnification and jurisdictional issues mentioned therein. The authenticity of this document may be verified at <http://www.sgs.com/certified-clients-and-products/certified-clients-directory>. Any unauthorised alteration, forgery or falsification in the content or appearance of this document is unlawful and offenders may be prosecuted to the fullest extent of the law.

STD 096
(Q-Mark Certificate)





CERTIFICATE OF REGISTRATION

This is to certify that

Sigma Factory for Steel Products
P.O. Box 37991
Dubai Industrial City
Dubai
United Arab Emirates

Meets the requirements of the Exova BM TRADA Q-Mark International Fire Door Manufacture scheme to **STD 096 - Issue 3 - 01/12/2015** which only operates in Bahrain, Egypt, Iraq, Jordan, Kuwait, Lebanon, Libya, Oman, Qatar, Saudi Arabia and The United Arab Emirates for the products on the attached schedule

Karen Prendergast
Sector Director - Certification
Exova BM TRADA

Certificate Number
476

Date of Initial Certification
16 June 2014

Date of last issue
13 October 2017

Date of Expiry
15 June 2020

Exova (UK) Ltd, (T/A Exova BM TRADA), Chiltern House, Stocking Lane, High Wycombe, Buckinghamshire, HP14 4ND, UK
Registered Office: Stone (UK) Ltd, Lochend Industrial Estate, Newbridge, Midlothian EH26 8PL, United Kingdom, Reg No: SC02942

This certificate remains the property of Exova (UK) Ltd. This certificate and all copies or reproductions of the certificate shall be returned to Exova (UK) Ltd or destroyed if requested. Further clarification regarding the scope of this certificate and verification of the certificate available through Exova BM TRADA or at the above address or at www.exovabmtrada.co.uk

The use of the UKAS accreditation mark indicates accreditation in respect of those activities covered by the accreditation/certification/ Q-Mark clients. The scope of certification shown above includes the participating sites shown on the registration schedule

Page 1 of 2

ISO 9001 : 2015
(Quality Management System)



Certificate of Registration

This is to certify that the Management System of:

Sigma Factory for Steel Products

P.O. Box 37991, Saih Suhaib - 3, 4 Round About, Dubai Industrial City, Dubai, United Arab Emirates.

has been approved by Alcumus ISOQAR and is compliant with the requirements of:

ISO 9001:2015



Certificate Number: 22244-Q15-001
Initial Registration Date: 23 February 2015
Previous Expiry Date: 22 February 2024
Recertification Date: 14 November 2023
Re-issue Date: 30 November 2023
Current Expiry Date: 22 February 2027

Scope of Registration:

Trading and Manufacturing of all kinds of Steel Related Construction Materials.

Signed:
Alyn Franklin, Chief Executive Officer
(on behalf of Alcumus ISOQAR)

This certificate will remain current subject to the company maintaining its system to the required standard. This will be monitored regularly by Alcumus ISOQAR. Further clarification regarding the scope of this certificate and the applicability of the relevant standards' requirement may be obtained by consulting Alcumus ISOQAR.

Registered in United Arab Emirates as BM TRADA VENTURES LLC (TRADING AS BMTV)
Unit 904, Business Avenue Building, PO Box 30945, Dubai, UAE



Alcumus ISOQAR Limited, Alcumus Certification, Cobra Court, 1 Blackmore Road, Stretford, Manchester M32 0QY.
T: 0161 865 3699 F: 0161 865 3685 E: isoqaenquiries@alcumusgroup.com W: www.alcumusgroup.com/isoqar
This certificate is the property of Alcumus ISOQAR and must be returned on request.

ISO 14001 : 2015
(Environmental Management System)



Certificate of Registration

This is to certify that the Management System of:

Sigma Factory for Steel Products

P.O. Box 37991, Saih Suhaib - 3, 4 Round About, Dubai Industrial City, Dubai, United Arab Emirates.

has been approved by Alcumus ISOQAR and is compliant with the requirements of:

ISO 14001:2015



Certificate Number: 22244-EMS-001
Initial Registration Date: 22 September 2015
Previous Expiry Date: 21 September 2024
Recertification Date: 04 June 2024
Re-issue Date: 04 July 2024
Current Expiry Date: 21 September 2027

Scope of Registration:

Trading and Manufacturing of all kinds of Steel Related Construction Materials.

Signed:
Alyn Franklin, Chief Executive Officer
(on behalf of Alcumus ISOQAR)

This certificate will remain current subject to the company maintaining its system to the required standard. This will be monitored regularly by Alcumus ISOQAR. Further clarification regarding the scope of this certificate and the applicability of the relevant standards' requirement may be obtained by consulting Alcumus ISOQAR.

OHSAS 45001 : 2018
(Health & Safety Management System)



Certificate of Registration

This is to certify that the Management System of:

Sigma Factory for Steel Products

P.O. Box 37991, Saih Suhaib - 3, 4 Round About, Dubai Industrial City, Dubai, United Arab Emirates.

has been approved by Alcumus ISOQAR and is compliant with the requirements of:

ISO 45001:2018



Certificate Number: 22244-OHS-001
Initial Registration Date: 22 September 2015
Previous Expiry Date: 21 September 2024
Recertification Date: 10 June 2024
Re-issue Date: 20 June 2024
Current Expiry Date: 21 September 2027

Scope of Registration:

Trading and Manufacturing of all kinds of Steel Related Construction Materials.

Signed:
Alyn Franklin, Chief Executive Officer
(on behalf of Alcumus ISOQAR)

This certificate will remain current subject to the company maintaining its system to the required standard. This will be monitored regularly by Alcumus ISOQAR. Further clarification regarding the scope of this certificate and the applicability of the relevant standards' requirement may be obtained by consulting Alcumus ISOQAR.

Registered in United Arab Emirates as BM TRADA VENTURES LLC (TRADING AS BMTV)
Unit 904, Business Avenue Building, PO Box 30945, Dubai, UAE



Alcumus ISOQAR Limited, Alcumus Certification, Cobra Court, 1 Blackmore Road, Stretford, Manchester M32 0QY.
T: 0161 865 3699 F: 0161 865 3685 E: isoqaenquiries@alcumusgroup.com W: www.alcumusgroup.com/isoqar
This certificate is the property of Alcumus ISOQAR and must be returned on request.

BS EN 61537:2007 (KEMA - KEUR Certified For Cable Management Products)

CERTIFICATE

Issued to:
Applicant:
Isam Kabbani Trading Est. (Unitech)
Rashidiya
Dubai, United Arab Emirates

Manufacturer/Licensee:
Sigma Factory for Steel Products (SFSP)
Saih Suhaib 3, 4RA, Dubai Industrial City,
Dubai, United Arab Emirates

Product : Cable management system
 Trade name : SFSP
 Types : IE-CT-X-10, IE-CT-X-12, IE-CT-X-15, IE-CT-X-20

The product and any acceptable variation thereto is specified in the Annex to this certificate and the documents therein referred to.

DEKRA hereby declares that the above-mentioned product has been certified on the basis of:
 - a type test according to the standard IEC 61537:2006 and EN 61537:2007
 - an inspection of the production location according to CENELEC Operational Document CIG 021
 - a certification agreement with the number 2156954

DEKRA hereby grants the right to use the KEMA-KEUR certification mark.

The KEMA-KEUR certification mark may be applied to the product as specified in this certificate for the duration of the KEMA-KEUR certification agreement and under the conditions of the KEMA-KEUR certification agreement.

This certificate is issued on: 20 January, 2014 and expires upon withdrawal of one of the above mentioned standards.

Certificate number: 2156954.01

DEKRA Certification B.V.

drs. G.J. Zoetbrood
Managing Director

H.R.M. Barends
Certification Manager

© Integral publication of this certificate is allowed

ACCREDITED BY THE
DUTCH ACCREDITATION
COUNCIL



DEKRA Certification B.V., Meander 1051, 6825 MJ Arnhem P.O. Box 5185, 6802 ED Arnhem The Netherlands
T +31 88 96 83000 F +31 88 96 83100 www.dekra-certification.com Registered Arnhem 09085396

UL Certification* (Cable Trays)

CERTIFICATE OF COMPLIANCE

Certificate Number 20160816-E483358
Report Reference E483358-20160816
Issue Date 2016-AUGUST-16

Issued to: Sigma Factory for Steel Products
 Saih Shuaib 3, 4 R/A Dubai Industrial City
 Opposite DEWA Substation
 Dubai UNITED ARAB EMIRATES

This is to certify that representative samples of CABLE TRAYS
 Steel Channel Cable Tray, Ventilated, Heavy Duty (HCT),
 Very Heavy Duty (VCT) cable trays.

Have been investigated by UL in accordance with the Standard(s) indicated on this Certificate.

Standard(s) for Safety: ANSI/NFPA 70, "National Electrical Code" (NEC)
Additional Information: See the ULC Online Certification Directory at www.ulc.ca for additional information

Only those products bearing the ULC Listing Mark should be considered as being covered by ULC's Listing and Follow-Up Service.

The ULC Listing Mark generally includes the following elements: the symbol ULC in a circle,  with the word "LISTED"; a control number (may be alphanumeric) assigned by ULC; and the product category name (product identifier) as indicated in the appropriate ULC Directory.

To confirm the status, validate the above information via the online directory.

Look for the ULC Listing Mark on the product.

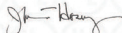
 Joseph Hesse, General Manager, Director of Sales - Canada
 UNDERWRITERS LABORATORIES OF CANADA INC.

Any information and documentation involving ULC Mark services are provided on license of ULC. For questions, please contact a local ULC Customer Service Representative.

Page 1 of 1

UL Certification* (Chute Type Fire Doors)

CERTIFICATE OF COMPLIANCE

Certificate Number 20170811-R38825
Report Reference R38825-20170811
Issue Date 2017-AUGUST-11

Issued to: Sigma Factory for Steel Products
 Saih Shuaib 3, 4 R/A Dubai Industrial City
 Opposite DEWA Substation
 Dubai UNITED ARAB EMIRATES

This is to certify that representative samples of CHUTE-TYPE FIRE DOORS
 Chute-type fire door and frame assembly of the insulated type, rated up to and including 2 hr, 450°F Temperature Rise Rating.

Have been investigated by UL in accordance with the Standard(s) indicated on this Certificate.

Standard(s) for Safety: ANSI/UL 10B, Fire Tests of Door Assemblies
Additional Information: See the UL Online Certifications Directory at www.ul.com/database for additional information

Only those products bearing the UL Certification Mark should be considered as being covered by UL's Certification and Follow-Up Service.

Look for the UL Certification Mark on the product.

UL Certification* (Fire Barrier)

CERTIFICATE OF COMPLIANCE

Certificate Number R40146
Report Reference R40146-20220524
Date 2022-May-25

Issued to: Sigma Factory for Steel Products
 Saih Shuaib 3, 4 R/A Dubai Industrial City
 Opposite DEWA Substation
 Dubai AE

This is to certify that representative samples of MECHANICAL JOINT ASSEMBLIES
 The products covered by this Section are mechanical joint assemblies designated Nexus Fire Barrier (NFB) for use in various joint systems described in the Fire Resistance Directory.

Have been investigated by UL in accordance with the Standard(s) indicated on this Certificate.

Standard(s) for Safety: UL 2079, Tests for Fire Resistance of Building Joint Systems

Additional Information: See the UL Online Certifications Directory at <https://iq.ulprospector.com> for additional information

This Certificate of Compliance does not provide authorization to apply the UL Mark. Only the UL Follow-Up Services Procedure provides authorization to apply the UL Mark.

Only those products bearing the UL Mark should be considered as being UL Certified and covered under UL's Follow-Up Services.

Look for the UL Certification Mark on the product.

 Bruce Mahrenholz, Director North American Certification Program

UL LLC
 Any information and documentation involving UL Mark services are provided on behalf of UL LLC (UL) or any authorized licensee of UL. For questions, please contact a local UL Customer Service Representative at ul@ulprospector.com



SFSP Products

SFSP produces a variety of products ranging from cable management systems; cable trays, cable ladders, basket trays, trunkings and support systems, to mechanical cladding fixations, steel lintels and block work accessories, plasterers' beads, expanded metal and block work reinforcement, strut channel systems, pipe clamps & hangers, gypsum profiles as well as garbage and linen chutes. With the introduction of new machines and the enhancement of production methods, SFSP continues to develop its production methods systematically as well as thoroughly. Its design office in Stuttgart, Germany provides a comprehensive design and calculation case studies, enabling the factory to have the safety factors required for the usage of its products.



MEP Solutions

Cable Management Systems

Cable Management Systems are economical and designed to meet most requirements of cable and electrical wire installations and comply to international standards of fabrication and finishing.

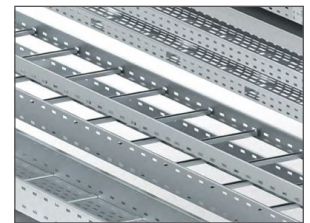

Cable Trays & Accessories

Cable Trays are designed to meet most requirements of cable and electrical wire installations and comply to local and international standards of fabrications and finishes.

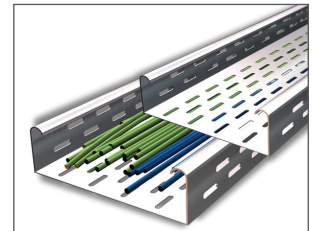

Cable Ladders (Welded & Swaged)

Cable Ladders of different side heights are available upon request.



Basket Trays & Accessories

SFSP's Basket Tray systems make connections fast and simple with limited need for tools. Its design allows for continuous airflow, and prevents heating up of cables. SFSP's Basket Tray comes in a full range of sizes and is made with high-strength welded steel wires.

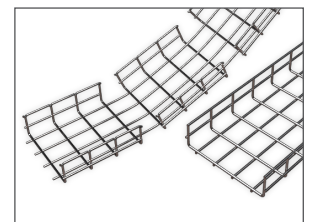

Cable Trunkings

Cable Trunkings and Accessories are offered in a comprehensive range. Mill galvanized, hot-dip galvanized, and powder coated are the various finishes produced in our factories.

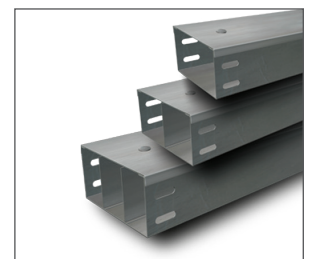

Underfloor Trunking

Underfloor Trunking Systems solutions incorporate a range of products for the distribution of power and data services , it is a coordinated set of containments that protect, segregate, contain, and route cables within a given environment.



Fiberglass Reinforced Plastic (FRP) Cable Tray / Ladder

SFSP Fiberglass Reinforced Plastic (FRP) Cable Management Systems are designed, manufactured, and tested to be installed in most harsh environmental conditions of onshore and offshore facilities for several industries including Oil and Gas, Petrochemicals, Manufacturing, Mining and others.

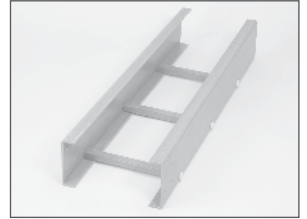

Cable Management Support Systems

Cable Support Systems are well designed to provide necessary support for cable trays, cable ladders and trunkings. Cable supports are manufactured according to common standards from high quality raw materials.

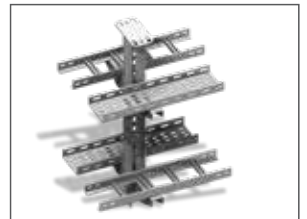

C-Channel Strut Systems

SFSP's Metal Framing Systems provide an economical solution for electrical, mechanical and industrial supports with a wide variety of applications in the construction industry.
Applications: - Pipe and Conduit Supports - Tunnel Pipe Stanchions - Racks and Shelvings - Wall Framings.



Pipe Clamps & Hangers

Pipe Clamps and Hangers from SFSP used in the support of pipes and equipments are manufactured according to the highest standards of fabrication. A diversified choice of Pipe Hangers, Pipe Clamps, EMT Straps, Omega Clamps, Beam Clamps, J and U-Bolts and Threaded Accessories.

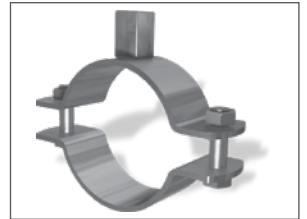

Galvanized Threaded Rods and Accessories

Threaded rod, often referred to as a stud, is a rod of varying length that is threaded in a helical structure. Similar in appearance to a screw, the threading extends around and along the rod to cause rotational movements when in use.



Access Panels by FEROX

Ferox Access Panels provides complete solutions of several types of access panels including Hook Type, Pivot Type, Tiled Type as well as fire rated access panels and hygienic access panels. A variety of finishes are available including stainless steel of different grades, galvanized steel with powder coating. Ferox Access Panels are manufactured from high quality material and assembled with stainless steel hardware.



Roof hatches by FEROX

Roof hatch provides safe and convenient access to commercial building roof areas using interior ladders and stairs for maintenance work. It can be installed on flat roofs with a maximum slope of 30°. Made of steel frames, doors and stainless steel hardware. Powder coated to provide corrosion resistance and outstanding exterior durability.





Architectural & Finishing Solutions

Mechanical Cladding Fixation (Stangle)

Stangle Cladding Fixation includes design, calculation and production of several types of mechanical fixings and accessories used for cladding purposes. Stainless and galvanized steel are among the various materials used in the fabrication.



Aluminium System for Stone Cladding

SFSP aluminum systems are designed and calculated to provide a practical & safe solutions of stone cladding. Wide range of aluminum profiles with different shapes to support different types of stone cladding.



Waste Management Sys. (Garbage & Linen Chutes)

Chutes from SFSP are very convenient, simple and low cost method of controlling and disposing of refuse and linen. Chutes meet the most stringent requirements of environmental health and safety.



Dry Wall & Ceiling Profiles

Gypsum Boards are considered among the most economic and ideal way for wall partitioning. Easy to install, saves time and money, gypsum boards can be used as a backing for wall treatments such as wall paper, fabric, tile and wood paneling or it can simply be painted.



Metal Ceiling Grid Systems

SFSP Ceiling Grid System is a practical, convenient ceiling system. It has a complete range of main c-channel sections and complementary parts so that you can adapt the modules to suit your design needs and load requirements.



Expansion Joint System by Nexus

Our variety of expansion joints includes profiles for walls and floors, profiles for seismic movements, watertight profiles. Our products suit pedestrian as well as heavy load traffic areas.



Entrance Matting System by Nexus

Nexus Entrance matting systems provides heavy duty entrance mats, composed of aluminium profiles with carpet, brushes or rubber inserts. For any design of any shape, being round, square, oval, or any other symmetrical or asymmetrical shape, Nexus offers a variety of entrance matting profiles



Profiles by Nexus

Nexus offer comprehensive solutions for the construction industry ranging from Expansion Joint Covers and Fire Barriers to Entrance Matting Systems, Wall and Floor Profiles, Tactile Solutions, etc... NEXUS range of products is manufactured according to most common international standards to meet the requirements of commercial, residential, governmental, transportation, healthcare and educational projects.



Phenolic Compartment by CUBIX

CUBIX phenolic compartment and partition systems are manufactured and customized to meet the precise needs of simple to complicated projects with its top-notch finish, quality of material and within a timely delivery. A complete solution with a wide selection of colors and textures are available.



Raised Access Flooring by PIXEL

PIXEL Raised Access Flooring offers comprehensive solutions of High Tech Raised Access Flooring Systems for the construction industry. PIXEL Raised Access Flooring are manufactured according to most common international standards to meet the requirements of commercial, residential, governmental, transportation, healthcare, and educational projects.

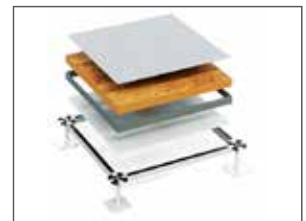

Metal Doors by FEROX

Ferox offers a wide variety of steel doors, manufactured according to international standards of fabrication and as per the legal requirement of commercial projects whether industrial environments, local authority buildings, leisure, hospitality, healthcare, transportation, education or retail offices, and shopping centers. Our range of steel doors includes fire rated steel doors, Insulated Doors, Acoustic Doors, Louvered Doors, Sliding Doors, Security Detonation Doors, Burglar Resistant Doors, Entry Gates and several other types to meet the requirements of all projects.



Civil Solutions

Expanded Metals, Plasterers' Beads

Expanded Metals help the formation of joints, protection of corners and resistance against cracks, chips and impact damage. SFSP manufactures in accordance with BS EN 13658 - 2, ASTM C847-18, BS EN 845-3:2003+A1:2008, ASTM A 951/A 951M - 2016 standards.

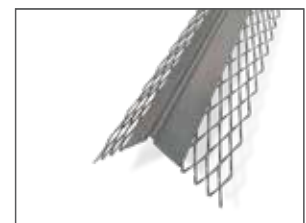

Block Ladder Reinforcement

SFSP ladder and truss types are used for the reinforcement of brick and block masonry to give improved tensile strength to walls subjected to lateral loading e.g. wind and seismic. SFSP Block reinforcements reduces the risk of cracking either at stress concentration around opening.



Steel Lintels & Block Work Accessories

Steel Lintels provide a combination of strength and light weight, resulting in efficient load bearing performance and increased productivity on site. They are characterized by their ease of installation in addition to time as well as money saving. SFSP manufactures Steel Lintel in accordance with BS EN 845-2:2013+A1:2016 and according to relevant standards BS 5977 Part 2:1983.



SFSP Products are solely distributed by UNITECH for Building and Construction Materials

KSA

Isam Kabbani & Partners for Building and Construction Materials Co., Ltd.

شركة عصام قباني وشركاه لمواد الأنشاء والتعمير المحدودة

BAHRAIN

Isam Kabbani Trading Est.

مؤسسة عصام قباني التجارية

UAE

Issam Kabbani Trading Company LL

شركة عصام قباني للتجارة

EGYPT

Unitech Egypt for Building Materials

شركة يونيتك مصر لمواد البناء

OMAN

Isam Kabbani & Partners Trading Co.

شركة عصام قباني وشركاه للتجارة

QATAR

Unitech Qatar for Building & Construction Materials Ltd., W.L.L

شركة يونيتك قطر لمواد الانشاء والتعمير المحدودة

KUWAIT

Hassan Kabbani for General Contracting Est.

مؤسسة حسان قباني للمقاولات العامة للمباني

LEBANON

Unitech ME s.a.r.l

شركة يونيتك ميدل إيست ش.م.م

PAKISTAN

Unitech IKK Pakistan (PVT.) LTD.

شركة يونيتك ميدل إيست ش.م.م

SFSP CUSTOMER SERVICE CALL CENTER

KSA

+966 13 8590097, Ext. 3214

UAE

+971 4 8181925, Ext. 4269



**STEEL
DOORS**

Standards & Specifications

FEROX's Metal Doors provide the best long-term value in the door and frame industry. It lasts longer, requires the fewest repairs, and is sturdier than other products. Steel's natural strength also outperforms other materials in security, fire rating, sound reduction, vandal resistance, sanitation, and more. Other door materials are still unable to match the performance and longevity of metal. Our metal doors offer endless options for attractive appearances.

Whether you are looking for a modern stainless steel appearance, a vibrant colored finish, or even a faux finish, metal's versatility allows it to satisfy the aesthetic requirements of any projects. Steel doors and frames even help the environment, as steel is the most recycled material worldwide.

ACOUSTIC PERFORMANCE

Hollow metal doors have the best STC performance characteristics. They are well suited to sound reduction specifications and offer a cost advantage in those environments. FEROX's steel door acoustic performance is up to 45dB. As a standard feature, doors are supplied with airtight seals and Rockwool insulation pads for enhanced acoustical properties, tested in accordance to ASTM C-553 , ASTM C-665 and BS EN 13162.

FIRE CLASSIFICATION

Full fire insulation tested in accordance to BS 476 : Part 22: 1987 Clause 6. Fire rated door set was tested for 120 minutes fire resistance in accordance to BS 476 : Part 22: 1987 and UL10B.

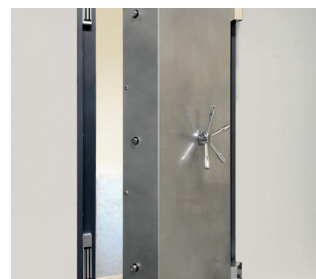
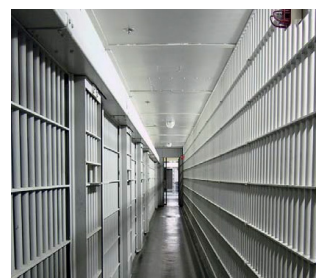
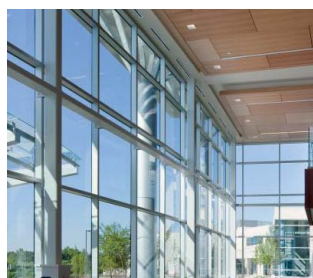

Humidity



Fire Classification



Green Building Material



Light Reflection



Antimicrobial



Cleanable



Acoustic Property



Bullet / Blast Resistance

FIRE DOORS (FD)

We provide a wide range of Fire Proof doors available with a variety of configuration and vision options. The doors are certified for up to 2 Hrs Fire Rating. These are manufactured to suit staircase, corridors, service rooms, entrance, etc.

FEATURES

- 120 mins Fire Resistance Rating
- Frame manufactured from GI Steel
- Easy installation
- Combination of safety, security and aesthetics



INSULATED DOORS (FI)

Full range of insulated doors with 30mins , 60 mins, up to 2 hrs fire rating. Designed to suit the power substations, cold stores, heat transfers applications and other similar locations.

FEATURES

- 30, 60, 120 mins Fire Resistance Rating
- Has continuously foamed in-place insulation
- With non-conductive thermal break
- Smooth and flush exterior finish
- Excels in energy efficiency and durability



LEAD LINED DOORS (LL)

The criteria to prevent penetration of X-Ray radiation through the door up to certain limits depend on the intensity and density of generated radiation from machines or equipments available in the room or laboratory. We supply Lead Lined Doors according to specific customer's requirements of the generated radiation intensity and density and specified test standards. These doors are mainly used to provide radiation protection in hospitals and health clinics.

FEATURES

- With lead sheets integrated into doors and frames for strength and vandal resistance
- Continuously welded, seamless door edge and lead lined frame



ACOUSTIC DOORS (AD)

A complete range of single and double door sets to suit the performance up to RW53 and 120 mins fire integrity to suit cinemas, studios, mechanical rooms, generator rooms and other sound polluted rooms.

FEATURES

- Noise reduction up to 45db
- Double up as security doors
- Adhere to fire safety regulations
- Long term performance and durability



PERSONNEL DOORS (PD)

A complete range of single and double door sets designed to satisfy the varied requirement of general purpose internal and external applications.

FEATURES

- Wide selection of sizes and style
- Quick and easy to install
- Available with variety of internal and external accessories



LOUVERED DOORS (LD)

We offer a wide variety of louver models and finishes within each category of louver types. The louvers serve a certain need and requirement within the air movement and control.

FEATURES

- Promote airflow and stable the temperatures in rooms
- Secure key areas
- Wide range of security upgrades, vision panels, door viewers and access devices



FIRE DOORS (GD)

From sturdy steel internal doors and secure apartment entrance doors to fully glazed office doors up to external doors with thermal break. These doors are made for special requirements such as heat and acoustic insulation, fire, blast and bullet resistance. We offer a large programme with diverse colors and equipment variants.

FEATURES

- With impressive thermal and acoustic insulation
- Bullet, Blast, Wind, Water and Impact resistant
- Energy-efficient
- Promotes high level of security



SLIDING DOORS (SL)

Sliding doors are horizontally sliding, top hung, single or multi-panel, single or bi-parting doors. The doors have track and roller assembly with all necessary accessories required for smooth operation. The sliding door has been tested for up to 150 min Fire integrity. These doors provide security for persons and goods in area like mass marketing, industrial storage etc.

FEATURES

- Heavy duty steel ball-bearing, tandem roller assembly
- Stainless steel track insert for sliding panels
- Painted finishes in standard and custom choices



GLAZED SCREENS (GS)

The visibility glazings are used as windows or room-high elements to provide more light and better visibility. Visibility glazing is also available for special requirements, i.e. in heat and acoustic insulation or radiation-proof versions, as well as in the fire-retarding F30 and fire resistant F90 variants.

FEATURES

- Available in multiple configurations
- Fire, blast, bullet and weather resistant
- Clean internal lines
- With hidden fixings and snap over glazing beads
- Accommodates any glass thickness



**SECURITY /
DETENTION DOORS**

MAIN ENTRANCE SECURITY DOORS (SME)

Sliding or hinged, single or double shutters, suitable for villa entry, conceived for protection from any forced entries or exits. Constructed from galvanized steel 2 or 2.5mm thick galvanized steel skins in a sandwich, with preparation for locks, reinforcement plates for surface mounted door closer and hinge cut-outs.

FEATURES

- Available in variety of profile types, sizes and hardware preparation
- Wide options of colors and equipment variants



PRISON ENTRANCE DOORS (SED)

Sliding or hinged door suitable for prison main entrance and other locations meeting the safety requirements and constructed to protect humans from any explosion or blast that may occur. Doors, windows and panels are constructed from galvanized steel as standard or Stainless steel as optional. Seamless shutters and panels are formed of thickness starting from 2mm thick galvanized steel or stainless steel skins in a sandwich construction.

FEATURES

- For maximum security application
- Blast, Bullet and Impact resistant



GRILL / CELL DOORS (SCD)

Sliding or hinged doors or fixed panels, suitable for prison cells, detention corridors or other detention premises. Used where full view of movement is required. Rigid and resistant to any impact or attack. Doors and panels are manufactured from round steel bars and rectangular hollow section tubes. Optional food hatch, shackle hatch, inundation points, anti barricade facility and constructed to suit the lock.

FEATURES

- Manufactured in standard sizes or bespoke units
- Highly durable and well-resistant to corrosion



BLAST RESISTANT DOOR (SBL)

Blast doors are specially designed for ensuring safety in buildings situated in hazardous or potentially explosive environments. Manufactured from steel, blast doors are constructed as a composite panel consisting of solid steel faces with heavy duty reinforcement stiffeners as core. Blast resistant steel doors and frames combine blast and air pressure resistance and yet function similarly to standard hollow metal products. When the door is under pressure in the out-swinging position, the latch mechanism and hinges are subject to severe structural loads. Our proposed door hardware has been specifically designed and tested to form an integral part of blast door units. We also provide high quality anti-corrosive coating, in a wide range of RAL colors, to enhance the performance and aesthetic appearance of blast doors and frames.

FEATURES

- Blast pressure up to 7 bars
- Wide variety of configurations and sizes
- Integrated high security locking systems
- Available with blast proof glazing



BULLET RESISTANT DOOR (SBU)

Bullet resistant door secures a building from ballistic attack while having the appearance of standard hollow metal products. Bullet resistant protection products are ranging from Level 1 (9mm hand gun) to Level 8 (12 guage rifled leadSlug). Doors, windows and panels are constructed from galvanized steel as standard and stainless steel as optional. Seamless shutters and panels are formed of thickness starting from 2mm thick galvanized steel or stainless steel skins in a sandwich construction, with preparation for locks, reinforcement plates for surface mounted door closer and hinge cut-outs. Pressed construction, produced from 2mm galvanized steel sheet or stainless steel.

FEATURES

- Available in GI and Stainless Steel
- Varied core infill layers
- Heavy duty steel frames to suit profile types, door sizes and hardware preparation



VULT ROOM DOORS (SVR)

Thieves have targeted vaults with a variety of sophisticated tools. As a result, vaults have evolved with an advanced array of anti-theft devices, including highly secure vault doors, alarms, combination dials and more. The FEROX range of vaults and vault doors offers certified protection against attacks from a variety of sources: crowbars, high-powered disc cutters and oxyacetylene torches, explosives, diamond-core drill bits and more.

FEATURES

- For high-risk security application
- Classified with 120 mins fire protection
- Secured with high security keyed or keyless lock
- With "wrapped around the wall" door frame to provide stronger resistance against attacks



BURGLAR RESISTANT DOORS (SBR)

Made of steel, the ultimate material for protection against violent attacks, anti-Burglary security door is made of a thick steel leaf (double 2 mm steel). The sectional frame and strong hinges are designed for extra strength. Dog bolts prevent tearing out of the door leaf even if the hinges have been severed. Solid steel reinforcements are integrated inside the leaf and frame, ensuring safety as well as aesthetic finish.

FEATURES

- High quality anti-rust galvanized steel door
- Frames installed with mortar
- Polystyrene filling, thermal and acoustic insulation
- Resistant to climatic effects



**ENTRY
GATES**

SLIDING DOORS & GATES (SSG)

Made up of 100x50x3mm Thick Steel Rectangular Hollow Section Main Frame. 50x50x1.5mm Thick Intermediate member. Flush Type Panel: Made up of 45mm thick (in regardless of tube size) covered with 1.2/1.5/2.0mm Thick Galvanized Steel Sheet conforms to ASTM A653-95, Commercial Quality. Insulated with Polyurethane Injection or Fiberglass.

Grille Type Panel: Made up of 50x50x1.5mm Thick Steel Square Hollow Section or 40x40x1.5mm Thick Steel Square Hollow Section. Or (Circular Hollow Section, Flat Bar, Round Bar, Square Bar) Gates will be provided with Bottom Track and Wheels, Top Roller Guide, Gate Catcher, Gate Stopper.



**TECHNICAL
SPECIFICATIONS
& HARDWARE**

STANDARD TECHNICAL DETAILS

STEEL DOORSET CHARACTERISTICS

- Strong durable and impact resistant
- Unaffected by moisture; will not warp, swell or rot
- Prepared & reinforced to receive a wide range of hardware
- Inherent hygienic properties
- Reduced maintenance and lower cost of ownership
- Enhanced security and acoustic characteristics
- Environmentally friendly - 100% recyclable
- Long life performance and improved life cycle costs

OPTIONS

- Single and double doorsets
- Single and double swing
- Side and over panels
- Banks of doorsets
- Vision panels
- Fully glazed option
- Fire block louvres
- Full range of premium hardware sets and accessories

SPECIFICATION INFORMATION

- CAD drawings - DXF or DWG versions
- NBS Specification (Document L20-Doors/Shutters/Hatches)

CLASSIFICATIONS

- BS 476 Part 22: 1987 (Fire integrity)
- BS 476 Part 22: 1987 CLAUSE 6 (Full Fire insulation)
- BS EN 1634-1: 2000 (New European standard)
- BS 5588-4: 1988 (Smoke passage)
- Underwriters Laboratories Inc.
- BS EN ISO 9001: 2000 (Quality Management System)
- Tested to 1 million cycles in accordance with EN 1191

FRAME PROFILES

- Materials: 1.50 - 2mm thick galvanized steel
- Profile: See Jamb Types.
- Jamb depth: 100 - 250mm

DOOR LEAF CONSTRUCTION

- Leaf thickness: 46mm Thick
- Material: 1.2 - 2mm thick galvanized steel

Door Ref:	Fire Integrity Rating			Sound Reduction (Optional)
	BS	EN	UL	
FD1001	1 hr	1 hr	0.75 hr	30Rw dB
FD1002	2 hr	2 hr	1.5 hr	30Rw dB

Note: When specifying, consideration should be given to sound transmission through surrounding building elements.
Rw dB: Weighted sound reduction index under laboratory conditions.

FIRE DOOR FEATURES

Frame infill to fire insulated, acoustic or thermally rated specification

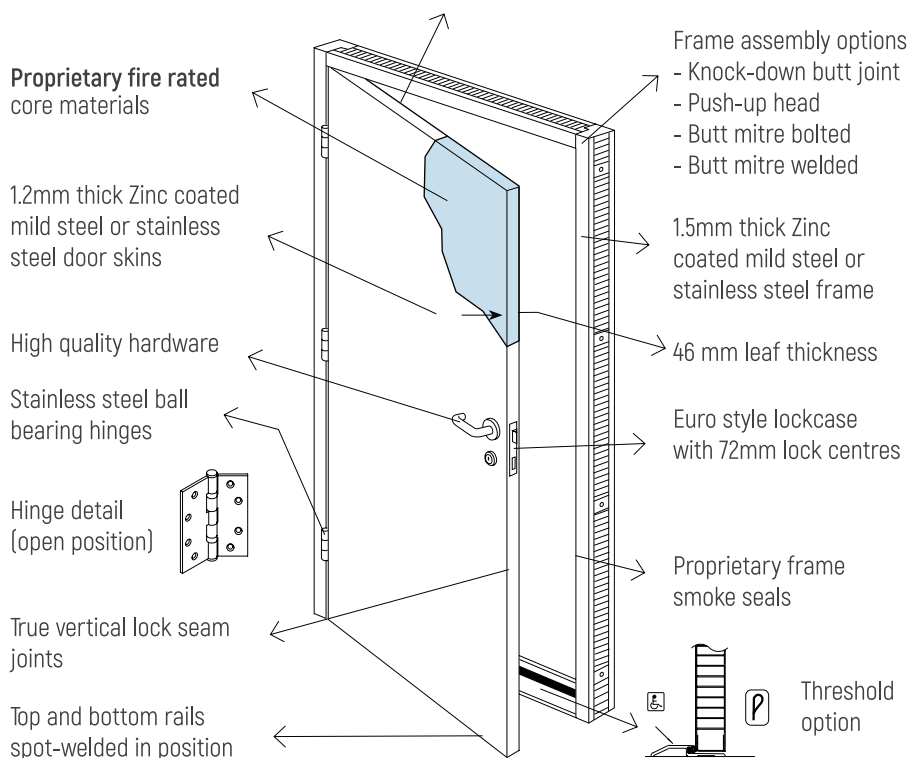

DOOR CONFIGURATIONS

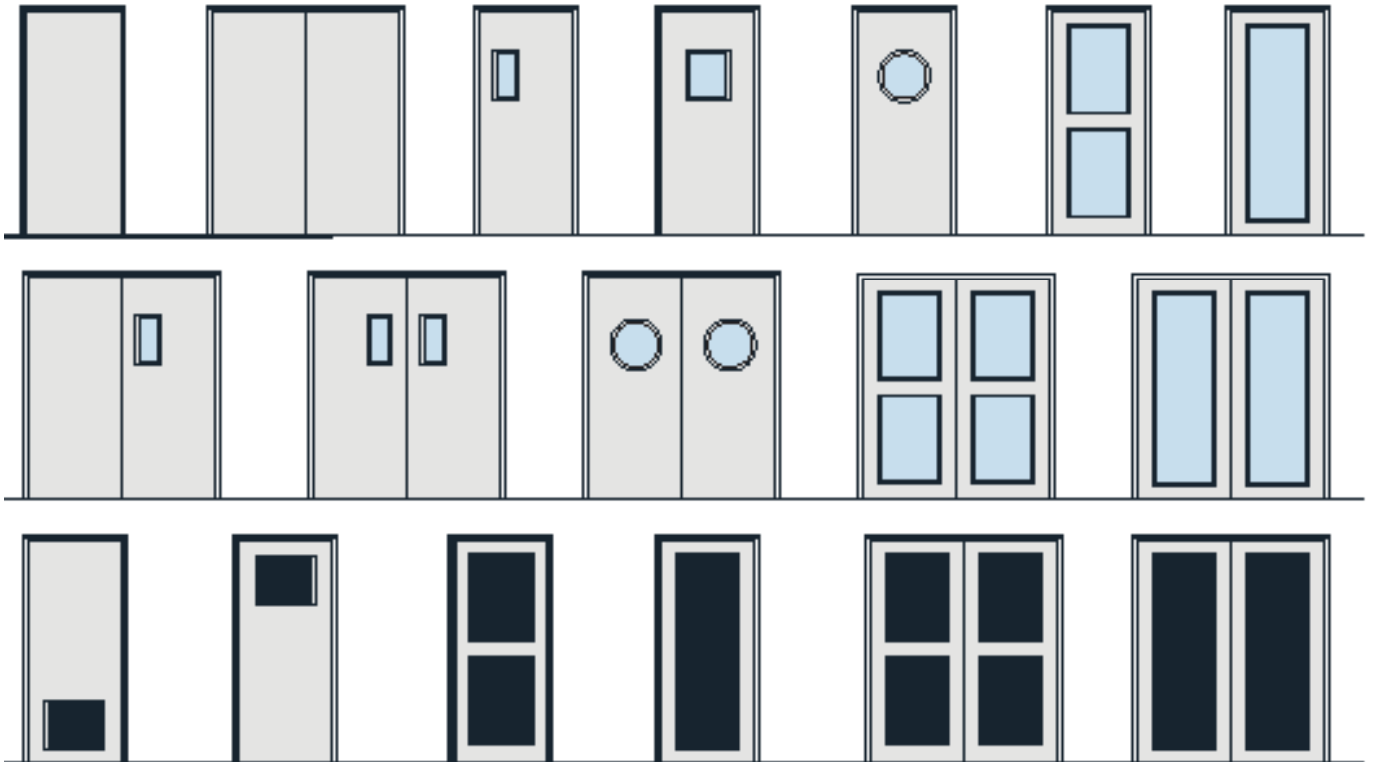

Note: Other door configuration can be available upon request.

HANDLING DIRECTIONS

SINGLE LEAF DOOR		DOUBLE ACTING DOORS	
<p>RH</p>	<p>LH</p>	<p>DA-RH</p>	<p>DA-LH</p>
<p>RHR</p>	<p>LHR</p>	<p>DA-RHA</p>	
DOUBLE LEAF DOOR		DA-LHA	
<p>R.H.A.</p>	<p>L.H.A.</p>	LEGENDS L.H. = LEFT HAND R.H. = RIGHT HAND L.H.A = LEFT HAND ACTIVE R.H.A = RIGHT HAND ACTIVE. DA-LH = DOUBLE ACTING LEFT HAND DA-RH = DOUBLE ACTING RIGHT HAND L.H.R. = LEFT HAND REVERSE R.H.R. = RIGHT HAND REVERSE L.H.R.A = LEFT HAND REVERSE ACTIVE R.H.R.A = RIGHT HAND REVERSE ACTIVE DA-LHA = DOB. ACT. LEFT HAND ACTIVE DA-RHA = DOB. ACT. RIGHT HAND ACTIVE	
<p>R.H.R.A.</p>	<p>L.H.R.A.</p>		

STANDARD DOOR FRAMES

MATERIAL

Galvanized Steel, Stainless Steel

THICKNESS

Gauge	14	16	18
Millimeters	2.0	1.5	1.2

TECHNICAL DATA FOR STANDARD FRAMES (DXH)

Double Rebate Frame	143 x 57 mm*		
Single Rebate Frame	100 x 57 mm	100 x 70 mm	
Frame Assembly	Mitered	Butted	Welded

STANDARD HEIGHTS (WALL OPENINGS)

Millimeters	2100	2200	2400	2700	3000
-------------	------	------	------	------	------

FRAMES

Available in mitered joint and butted assembly, our frames are supplied in knock down form for easy assembly at site. Welded frames are supplied on special request.

FEATURES

- Available in galvanized and stainless steel
- Frames available in single and double rebate
- All frames are prepared for receiving hardware
- Frames can also be designed for flush fixing
- Primed and finish painted

OPTIONAL

- Frames with Architrave
- Frames with in built seals



PREPARATION

HINGE JAMB

4 mm thick steel hinge reinforcement door and frame for receiving the hinge.

STRIKE JAMB

3 mm thick steel lock strike reinforcement with tapped holes welded to the frames.

MORTAR GUARD

1.2 mm thick steel plaster guard or mortar guard is provided at the back of all hardware cutouts in the frame.



Hinge Jamb



Strike Jamb



Hinge Mortar Guard



Strike Mortar Guard

JAMB TYPES

	WITHOUT ARCHITRAVE	ONE SIDE ARCHITRAVE	TWO SIDE ARCHITRAVE
SINGLE REBATE			
DOUBLE REBATE			
SINGLE REBATE W/SEAL			
SWING DOORS	<p>Anchor hole covered by plastic caps</p> <p>SERIES S AND D STANDARDEO/N: SPOT WELDED TO SOFFIT</p>		<p>NOTE:</p> <ol style="list-style-type: none"> 1. FRAMES VARIES AS PER CLIENT SIZE. 2. OUR MINIMUM FRAME STOP IS 19MM. 3. INSULATION VARIES AS PER REQUIREMENT: <ul style="list-style-type: none"> -Honeycomb -Rockwool -Polystyrene -Polyurethane 4. LEAF CAN BE ADDED WITH STIFFENERS

KNOCKDOWN FRAMES

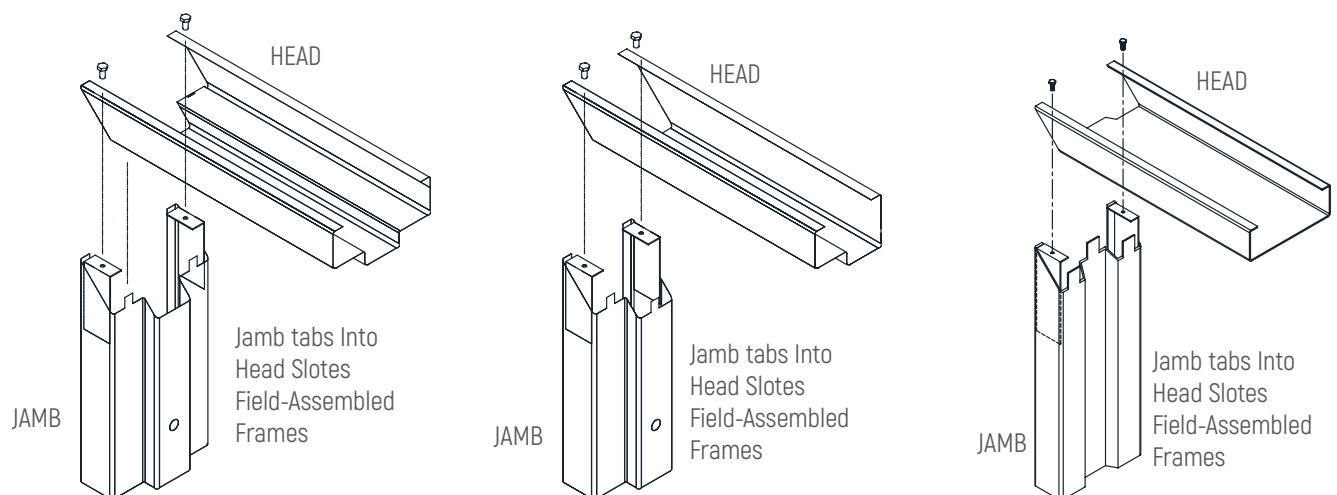

STANDARD HARDWARE OPTIONS

IRONMONGERY SET OPTIONS

To simplify the specification of ironmongery for your Steel Door sets, we have pre-selected a number of standard ironmongery set functions suitable for most door opening requirements.

These sets have been produced using over 10 years experience of supplying steel performance doors to construction industries across the world.

Each set has been drawn up from our ironmongery and has been carefully chosen to provide functionality, robust performance and stylish design. Our brand is synonymous with high quality design, reliability and durability and is at the forefront of supplying products that meet new European standards.

PANIC DEVICE

Panic bolt and panic latch are supplied in a silver finish. When as a pair on double doors a box keep is also supplied as part of the set. Panic hardware is CE marked to EN 1125.

OUTSIDE ACCESS DEVICE

Outside access device (OAD) supplied in a silver finish. The lever operated unit is supplied complete with Euro profile cylinder.

PULL HANDLE

Stainless steel pull handle with concealed face fixing roses. the 20mm diameter pull has 300mm centres making it compatible with the dimensional requirements of BS 8300. Produced in Grade 304 stainless steel with a brushed finish.



PUSH PLATES

For use in conjunction with the pull handle is a stainless steel push plate 300x 75mm supplied with countersunk head self tapping screw fixings. Produced in Grade 304 stainless steel with a brushed finish.

HINGES

Stainless steel ball bearing butt hinges in Grade 304 stainless steel with a brushed finish. Hinges are to EN 1935 Grade 13 and tested to 1 million cycles. Designed specifically for use with steel doors the hinge is template drilled for accuracy of fitting with machine screws.

ESCUTCHEONS

Matching lock function escutcheons or bathroom set with concealed fixings for use with Briton lever or pull handle furniture. Brushed finish Grade 304 stainless steel.

OVERHEAD DOOR CLOSER

Overhead door closer in silver finish. The closer has adjustable power and back check facility. Door closer can be fitted on the push or pull side of the door. Closers are CE marked to EN 1154.

LEVER HANDLE

Contract series rose mounted 19mm diameter lever furniture with concealed bolt through fixings for stability and durability. Levers comply with the performance requirements of EN 1906.

MORTICE LOCK CASES

Lock cases have Euro style 72mm centres (78mm bathroom) and a 5 mm backset. The forend is satin stainless steel with matching a strike plate. Locks are CE marked to EN 12209 and comply with the dimensional requirements of BS 8300. Supplied complete with temporary cylinder & turn where appropriate.

SIGNAGE

- Fire exit - Rigid plastic white/green (200 x 600mm)
 - Fire exit keep clear - Rigid plastic white/blue (200 x 200mm)
 - Push bar to open - Self adhesive white/green (90 x 500mm)
 - Fire door keep locked (80 x 80mm)
 - Fire door keep shut (80 x 80mm)
- All signs comply with BS5499.

FLUSH BOLT

Lever action concealed flush bolt, factory fitted into the leading edge of the inactive leaf of a pair of doors. Supplied as a pair for the top and bottom of the door. SCp finish.

DOOR SELECTOR

To coordinate the closing order of a pair of doors. Silver finish.

DOOR STOP

Floor mounted door stop.

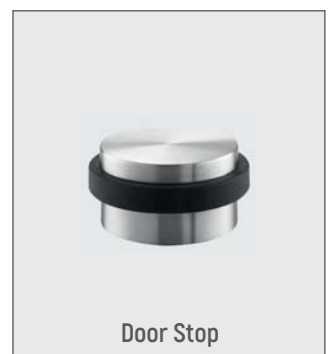
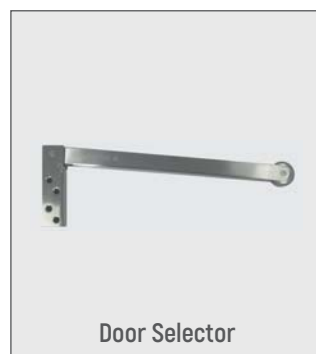
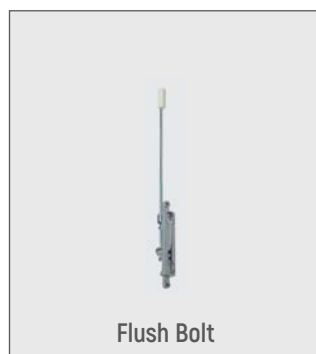
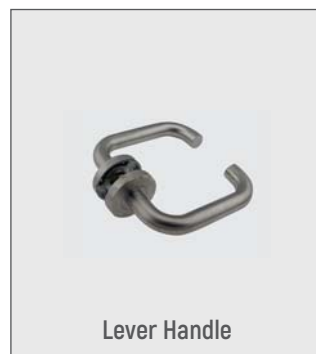
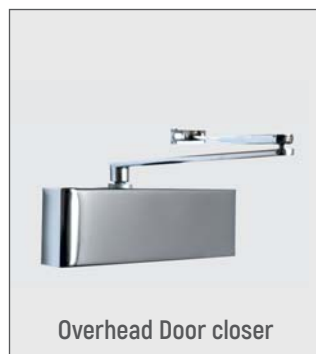
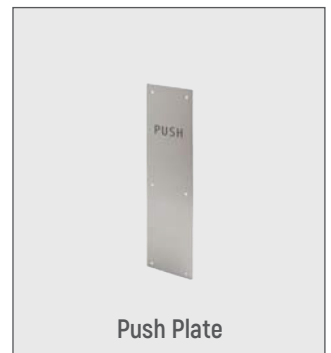
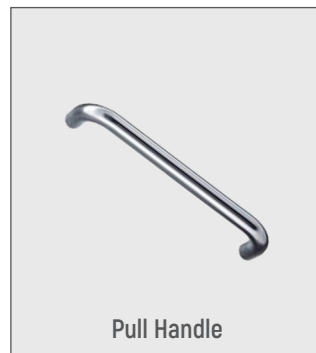
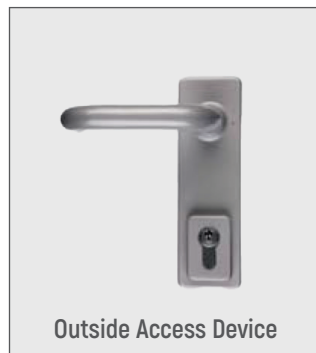

STANDARD MATERIALS AND FINISHES

MATERIALS

- Galvanized steel
- Stainless steel grade 304 & 316

FINISH PERFORMANCE

- Corrosion-Resistant
- Cleanable
- Antimicrobial (Optional)

FINISHES

- Epoxy Powder Coated
- Polyester Powder Coated
- Textured
- Smooth
- Mirror Finish
- Brush Finish
- Standard RAL Colors

Note : Other finishes can be available upon request.

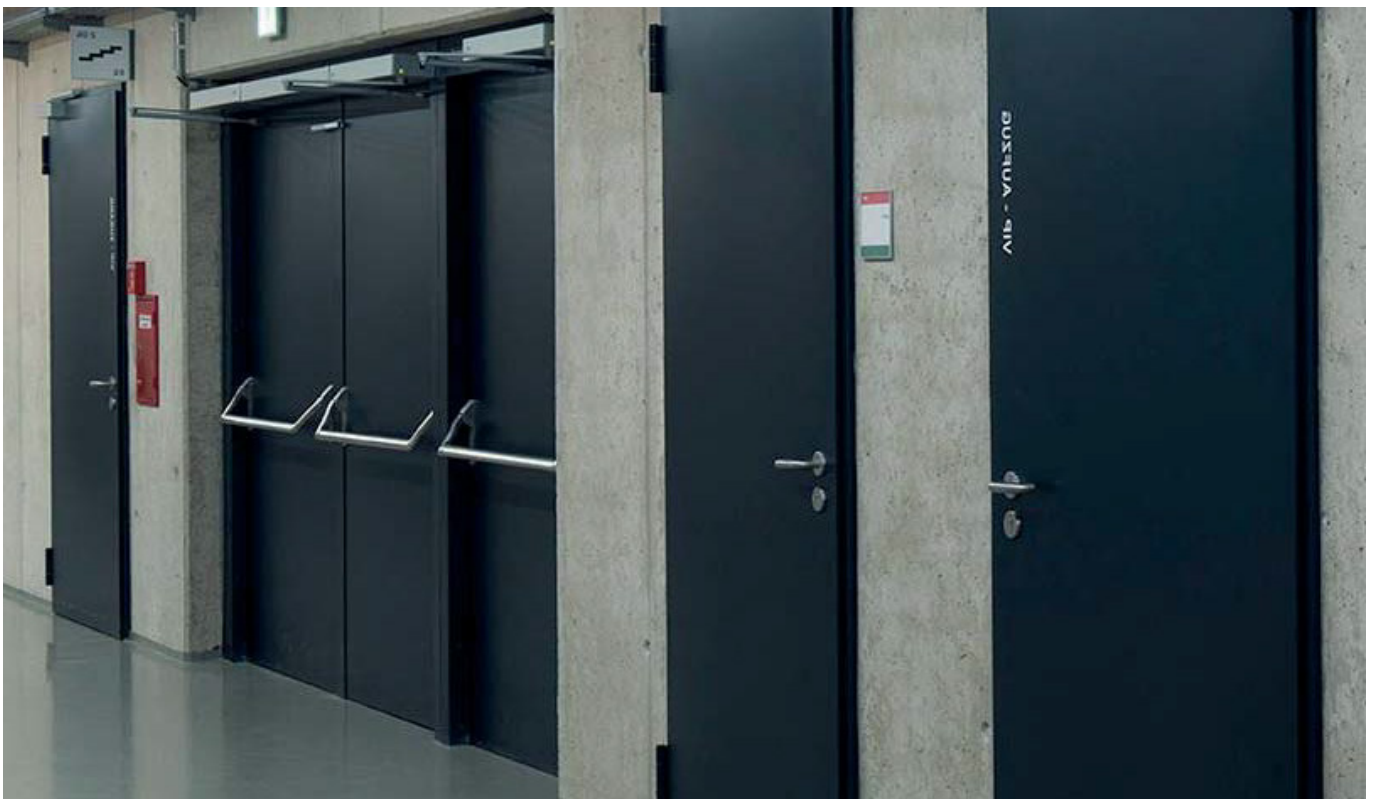

**CONTACT
INFORMATION**

Contact Information

Sales Offices/Entities

KINGDOM OF SAUDI ARABIA unitech.ksa@ikkgroup.com

Jeddah

Tel : +966 12 627 8222

Mak kah/Taif

Tel : +966 12 541 1206

Mad inah

Tel : +966 14 8420959

Yanbu

Tel : +966 14 396 8885

Khamis Mushayt

Tel : +966 17 237 5929

Gizan

Tel : +966 17 321 6660

Riyadh

Tel : +966 11 292 8200

Qassim / Buraidah

Tel : +966 16 316 1122

Tabuk

Tel : +966 14 423 5203

Dammam

Tel : +966 13 859 0097

Hufuf

Tel : +966 13 530 1474

Jubail

Tel : +966 13 361 4390

UNITED ARAB EMIRATES

Dubai - Al Rashidiyah

unitech.dubai@ikkgroup.com
Tel : +971 4 2591 773

Abu Dhabi - Musaffah

unitech.auh@ikkgroup.com
Tel : +971 2 552 3393

BAHRAIN

Manama

unitech.bahrain@ikkgroup.com
Tel : +973 17 874 897

KUWAIT

Kuwait City

unitech.kuwait@ikkgroup.com
Tel : +965 2 2459 984

QATAR

Doha

info@unitech-qatar.com
Tel : +974 4451 3301

OMAN

Muscat

unitech.oman@ikkgroup.com
Tel : +968 24 591 006

LEBANON

Beirut

unitech.lebanon@ikkgroup.com
Tel : +961 1 858 277

EGYPT

Cairo 6th of October City

unitech.egypt@ikkgroup.com
Tel : +20 2 3820 6477

PAKISTAN

Lahore - Punjab

unitech.pakistan@ikkgroup.com
Tel : +92 42 32301578

SFSP Factories

SFSP - KSA

Specialized Factory for Steel Products
sfsp.jeddah@ikkgroup.com

3rd Industrial City / Jeddah

Tel : +966 12 637 4482

SFSP / UAE

SIGMA Factory for Steel Products
sfsp.uae@ikkgroup.com

DIC (Dubai Industrial City)

Tel : +971 4 818 1919

SFSP / EGYPT

Specialized Factory for Steel Products
sfsp.cairo@ikkgroup.com

6th of October City Giza

Tel : +20 2 3820 6477

SFSP / LEBANON

Specialized Factory for Steel Products / s.a.r.l
sfsp.lebanon@ikkgroup.com

Tanayel, Bekaa

Tel : +961 8 514 290

Engineering & Design

GERMANY

unitech.germany@ikkgroup.com

United Deutschland GmbH Stuttgart, Germany

Tel : +49 711 6868 7222

Marketing & Multimedia

Multi-D s.a.r.l

multi-d@ikkgroup.com

Multi-D

Beirut, Lebanon

Tel : +961 1 841 155

